



HACO
GSX 3006R

GSX SERIES

Hydraulic Guillotine Shears

Hydraulics

The hydraulic guillotine shears of the GSX range are driven by top mounted cylinders. Our long experience in the production of hydraulic guillotine shears guarantees a product of exceptional design and great efficiency.

The fully open rear side provides the operator the possibility of easy removal or adapting different conveying systems to the machine.

The all-welded interlocked construction makes the machine virtually indestructible. The GSX shears are well equipped and have as standard the SC101 T controller.

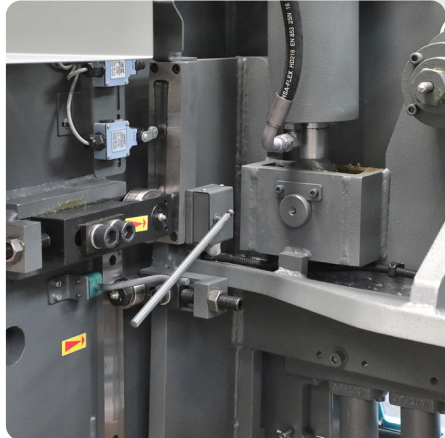

Hydraulics

The hydraulic system consists of a motor pump group and a multifunction manifold block for the control of the machine, easy access at the side of the machine. The connections to the cylinders, the hold downs and pumps are by means of flexible hoses. Two high pressure relief valves protect the hold downs and the cutting cycle from overload. Oversized oil tank for trouble free high production shearing.

The parallelism control of the ram is based on the so-called differential principle. Guiding of the beam by roller bearings on hardened ways.

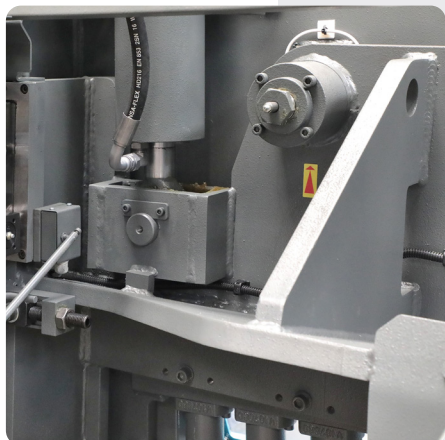

Hydraulics hold downs

The hydraulic hold downs work independently, which makes it possible to clamp plates of different lengths and thicknesses correctly. The hold downs operate independently from the shearing pressure. On the left and the right hand side of the machine the hold downs are arranged more closely to allow cutting small plates without any problems.

Cutting angle/blade gap adjustment

GSX 3006

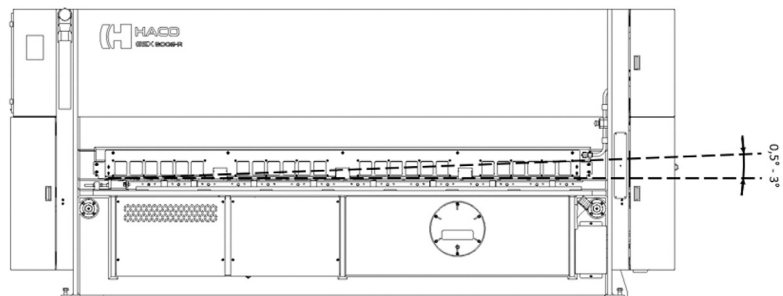

CUTTING ANGLE ADJUSTMENT

Automatic setting as a function of the plate thickness with SC101 T control. This allows to cut thin material at a lesser angle, minimizing deformation of the sheared plate.

BLADE GAP ADJUSTMENT

The blade clearance is set automatically by means of two hydraulic cylinders, as a function of the entered sheet thickness and material type.

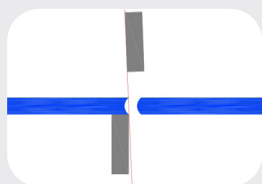

Too small

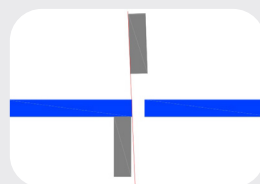

Correct

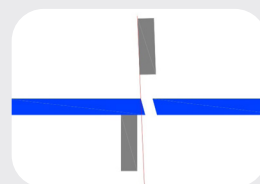

Too big

Standard features

Standard features of the GSX

- 2 Upper-driven push-down cylinders
- All operator controls are conveniently located at the left-hand side of the machine in the immediate reach of the operator
- Squaring arm of 1000 mm with scale, T-slot and tilling stop, attached to the left hand side of the machine
- Movable foot pedal control
- Instructions and maintenance manual
- Non-filled oil tank (because of environmental regulations)
- Service tools
- Iron square plate support blocks with ball transfers



SC101 T Control

Basic features

- LCD display (5.7") and Touch Screen
- Memory capacity:
Max. 500 programs with each max. 255 steps.
Material list of max. 32 materials
- Electro-hydraulic blade gap setting by means of 2 cylinders
- Stroke control adjustment (cutting length).
- Automatic programmable retraction of the back gauge
- Possibility of jog mode on back gauge.
- Backlash compensation, delayed sheet release.
- Mode selection Inch-Metric
- Preset counter with 0-stop
- USB interface

Programming Modes

- **Automatic**
By entering the sheet thickness, the control automatically sets the blade gap and the cutting angle as a function of the sheet thickness. All parameters can be manually modified according to the actual data.
- **Manual**
All cutting parameters such as material type, sheet thickness, cutting angle and blade gap can be programmed manually.

GSX 3006

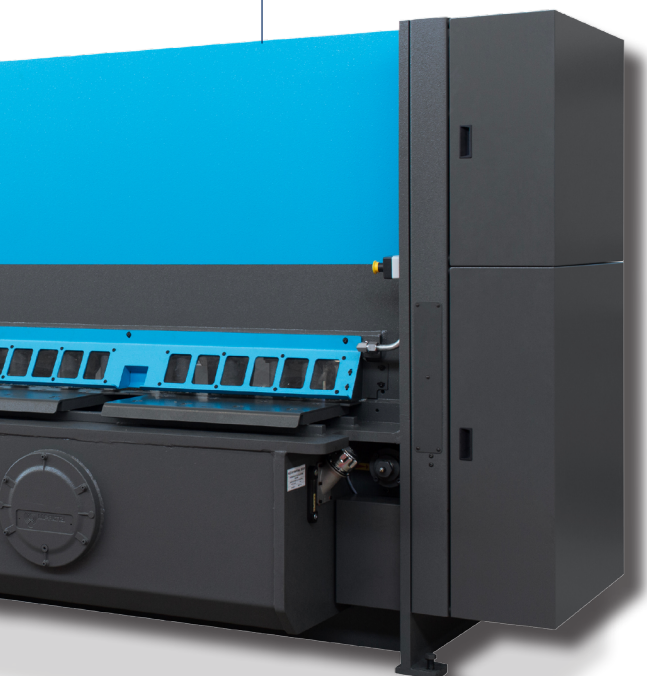

Quick and easy

The **SCI01 T** fits all requirements for sheet cutting operations that require the highest accuracy and minimum time-loss. Creating a program requires only a few actions. The program parameters include: back gauge position, cutting time, sheet thickness, blade angle & blade gap setting. The blade gap adjustment is done electro-hydraulically.

No specific training is required to work with this control!

Back gauges



The back gauge consists of 2 rigid arms (containing guidings and ball screws) and the parallel adjustable back gauge bar. This assembly assures a precise positioning of the sheet. Programmable positioning with the **SCI01 T** control. Digital read-out of the actual and preselected or programmed position. Swing-away back gauge enables cutting of sheets longer than the standard stroke length, driven on ball screws.

Motorised back gauge (MOT)

Lateral movement front to back.
Standard on all models.
Powered back gauge, stroke 1000 mm.

Swing-away back gauge (SAB)

Powered back gauge, stroke 1000 mm.
Available as option.
When removing the shafts in both carriers and running the backstop backwards, the complete carrier will swing away to the back, enabling to cut longer sheets.

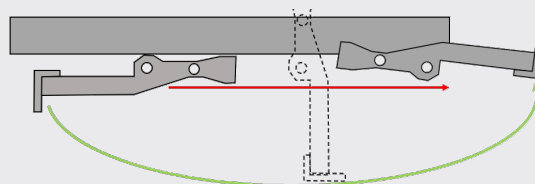

Optional equipment

Optionals

- Squaring arms and front support arms.
- Protractor for angle shearing.
- Hand Safety Guard with safety light curtain.
- Swing-away back gauge.
- Full table with ball transfers.
- Pendant control arm.
- Safety fences and light beams at the rear side of the machine. (standard for countries requiring the CE safety specifications)
- Soft padded hold downs.
- Hydraulic sheet support system with Sheet Back to Sender functionality (SBS).

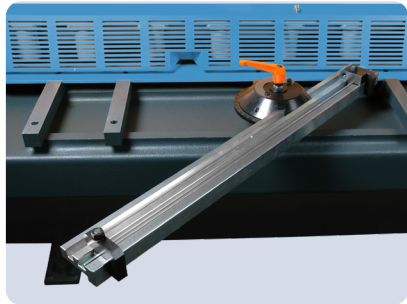

Protractor for angle shearing.

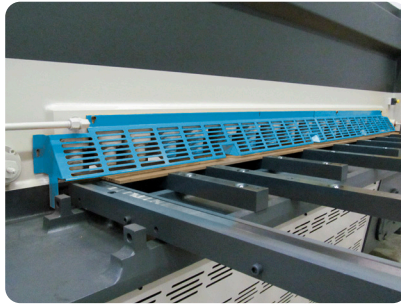

Squaring arms and front support arms with or without scale, T-slot, and tilting stop. Lengths from 1000 to 3000 mm per multiple length of 500 mm.

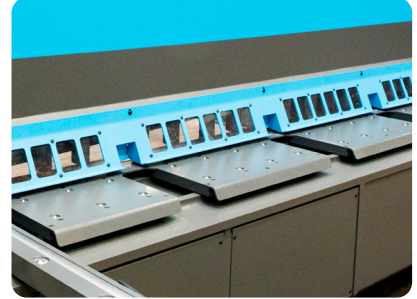

Full table consisting of segments, with ball transfers for easy feed-in of the sheets

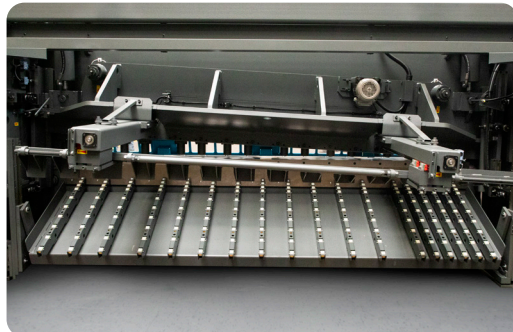

Hydraulic sheet support system with Sheet Back to Sender (SBS)

A specific feature of the GSX range is the complete free rear space between the frames, so the machine can be executed with different sheet support systems to improve production output.

The hydraulic sheet support system follows the movement of the beam. Principally for thinner sheets, it assures the perfect gauging while entering the sheet into the machine. During the cutting action the sheet remains supported in order to avoid damage and deformation. When the cutting action is finished the plate slides down smoothly. The system can be switched off, e.g. for cutting thicker plates.

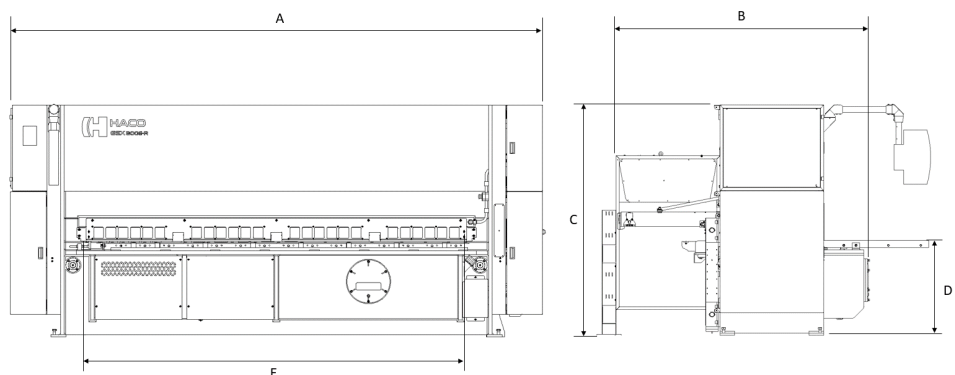
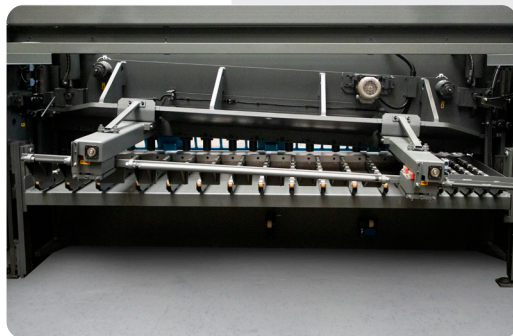

Technical specifications

	Capacity mild steel [mm] (420 N/mm ²)	Capacity stainless steel [mm] (700 N/mm ²)	Cutting length [mm]	Cutting angle (°)	Number of plate clamps	Number of strokes/min sheet with sup- port OFF at min. angle - max. angle	Number of strokes/min with sheet sup- port ON at min. angle - max. angle	Stroke of back gauge MOT version [mm]	Stroke of back gauge SAB version [mm]	Working height [mm]	Motor Power [kW]	Length [mm]	Width [mm] (without CE safety fences)	Width [mm] (with CE safety fences)	Height [mm]	Approximate weight (with SBS) [kg]
GSX2006	6,5	4,5	2050	0,5-2,5	14	28-15	7,5-7,5	1000	945	770	11	3340	2550	3900	1900	5000
GSX2008	8	5,5	2050	0,5-2,5	14	28-15	7,5-7,5	1000	945	770	15	3340	2550	3900	1900	5500
GSX2010	10	7	2050	0,5-2,5	14	14-12	8-6	1000	945	900	18,5	3650	2590	4110	1900	6800
GSX2013	13	9	2050	0,5-2,5	14	14-12	8-6	1000	945	900	22,5	3650	2590	4110	1900	8000
GSX2506	6,5	4,5	2550	0,5-2,5	14	25-12,5	6-6	1000	945	770	11	3840	2550	3900	1900	5500
GSX2508	8	5,5	2550	0,5-2,5	14	25-12,5	6-6	1000	945	770	15	3840	2550	3900	1900	6000
GSX2510	10	7	2550	0,5-2,5	14	11-9,5	6,5-5	1000	945	900	18,5	4150	2590	4110	1900	7500
GSX2513	13	9	2550	0,5-2,5	14	11-9,5	6,5-5	1000	945	900	22,5	4150	2590	4110	2100	8700
GSX3006	6,5	4,5	3050	0,5-2,5	18	20-10	5-5	1000	945	770	11	4340	2550	3900	1900	6500
GSX3008	8	5,5	3050	0,5-2,5	18	20-10	5-5	1000	945	770	15	4340	2550	3900	1900	7000
GSX3010	10	7	3050	0,5-2,5	18	9,5-8	5,5-4,5	1000	945	900	18,5	4650	2590	4110	2250	8500
GSX3013	13	9	3050	0,5-2,5	18	9,5-8	5,5-4,5	1000	945	900	22,5	4650	2590	4110	2250	9700
GSX3606	6,5	4,5	3650	0,5-2,5	22	16-8	4-4	1000	945	870	11	4940	2550	3900	2100	8000
GSX3608	8	5,5	3650	0,5-2,5	22	16-8	4-4	1000	945	825	15	4940	2550	3900	2100	9000
GSX3610	10	7	3650	0,5-2,5	22	8-6,5	4,5-4	1000	945	1000	18,5	5150	2590	4110	2250	11500
GSX3613	13	9	3650	0,5-2,5	22	8-6,5	4,5-4	1000	945	1030	22,5	5150	2590	4110	2250	12000
GSX4006	6,5	4,5	4050	0,5-2,5	22	15-7,5	4-4	1000	945	870	11	5340	2590	3940	2090	10000
GSX4008	8	5,5	4050	0,5-2,5	22	15-7,5	4-4	1000	945	880	15	5340	2590	3940	2090	10500
GSX4010	10	7	4050	0,5-2,5	22	7-6	4-3	1000	945	1000	18,5	5650	2590	4110	2250	13000
GSX4013	13	9	4050	0,5-2,5	22	7-6	4-3	1000	945	1030	22,5	5650	2590	4110	2250	13500

E

D

A

B

C



Machinery Masterminds

WWW.HACO.COM

HACO Belgium

Hogeschuurstraat 2
8850 Ardooie
Belgium
+32 (0)51 26 52 00
sales@haco.com

HACO India

Plot No. 122A, Sector 6
MT, Bawal, Distt. Rewari Haryana,
India, 123501
+919996246805
sales@haco-india.com

HACO USA

11629 N. Houston Rosslyn Rd.
Houston, TX 77086
USA
+1 281 445-3985
sales.tx@hacoatlantic.com

HACO Slovakia

Ulica 1. Mája 1850
031 80 Liptovský Mikuláš
Slovakia

HACO France

Parc d'activé de la Houssoye
Rue René Laënnec
59253 La Chapelle D'Armentieres
France
+33 3 20 10 30 40
commercial@haco.fr

HACO Australia

16 Argong Chase
Cockburn Central WA 6164
Australia
+61 0 8 9414 7382
sales@hacoaustralia.com.au

GSX / 03.2024

This catalog is not a contractual document and only for illustrative purposes. Haco reserves the right to modify any specifications within this catalog without prior notice.