

TS / TSX



TS / TS(X)
Hydraulic guillotine shears

AUTO BLADE GAP

All HACO shears are recognised for being well-built, accurate and cost-effective, meeting the demand for the high precision sheet metal and heavy fabrication market to run small or high-volume production.

All our TS shears are equipped with power rake angle adjustment from the SP9 control panel and quick blade gap adjustment.

Both 6 and 12 mm models are available with our SC100 T control (TSX types). These machines are delivered with an extensive range of standard features.

The TS/TSX series shears remain the pacesetters in the price/quality ratio market of today. With thousands of units running day after day all over the world, we are convinced of the durability and craftsmanship of these machines.



AUTO BLADE GAP (TSX)

Automatic blade gap adjustment in function of the material thickness by means of 2 hydraulic cylinders.

MANUAL BLADE GAP (TS)

Our quick blade gap adjustment is located conveniently in front of the machine. Adjustment ranges from 0,05 mm blade gap for thin sheet thicknesses and progressively increases for heavier thicknesses up to the maximum shear capacity.

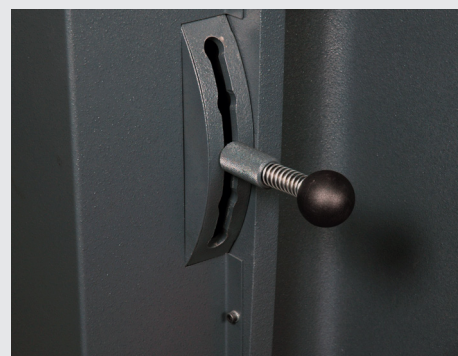

HYDRAULICS AND RAKE ANGLE

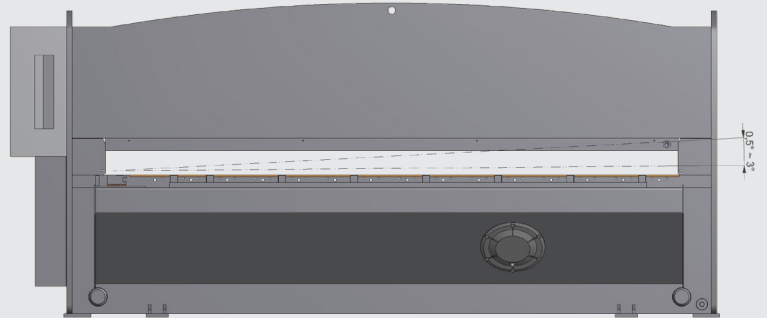

ADJUSTABLE RAKE ANGLE

Electro-hydraulic adjustment of the rake angle by push buttons at the control panel, with digital readout, allows thin material to be cut at less angle, minimising deformity of the sheared stock.

HYDRAULICS

TS/TSX shears are bottom driven by 2 pull-down cylinders. The hydraulic system consists of a motor pump unit and multi-function manifold block, conveniently located at the rear of the machine. This compact assembly brings valves and hoses together, thus simplifying the system and eliminating troublesome leaks.

The connections to the cylinders, the hold-downs and pumps are by means of flexible hoses. Two high pressure relief valves protect the hold-downs and the cutting cycle from overload. Oversized oil tank for trouble-free production shearing.

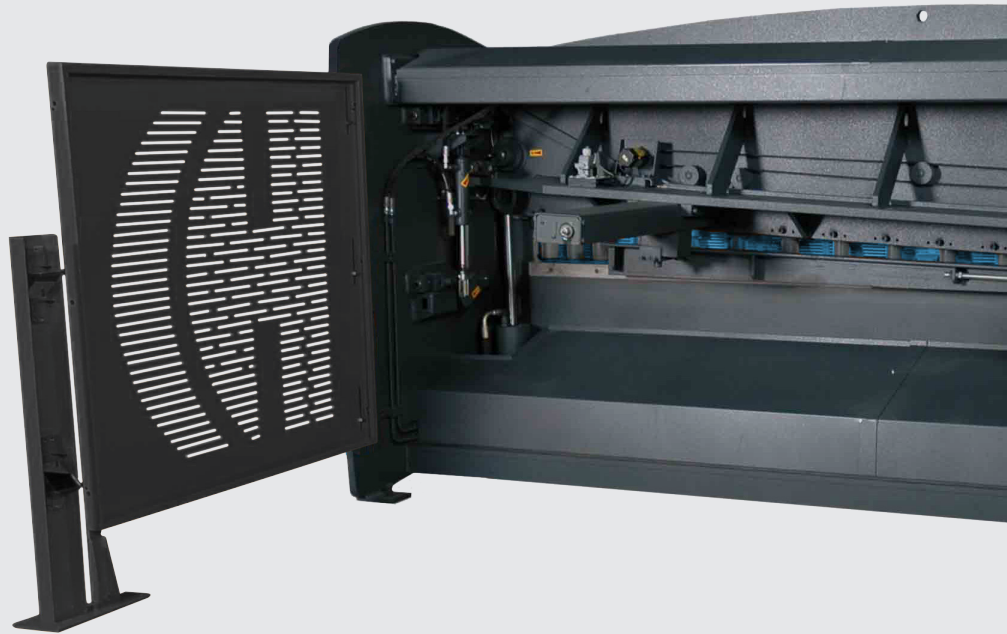

STANDARD FEATURES

STANDARD FEATURES OF TS-RANGE

- Hydraulic motor-pump group arranged at the rear of the machine, easily accessible and protected by a sheet cover.
- 2 under driven cylinders. Electro-hydraulic adjustment of the rake angle by push-buttons on the control panel.
- All operator controls are conveniently located at the left-hand side of the machine within the immediate reach of the operator.
- The standard SP9 control offers the following functions: automatic positioning of the back gauge to the preselected position with digital readout, stroke control, counter and selection for back gauge retraction.
- Quick blade gap setting by means of one easily accessible lever at the front of the machine.
- Tilting sheet hold downs, pressure of which is independent from the shearing pressure, in order to clamp properly each sheet thickness. These hold downs are arranged more closely on the left and the right-hand side to conveniently cut small parts.
- Hydraulic and electric overload protection.
- 4 edged cutting blades.
- On all models, motorised back gauge. On 6 mm stroke 750 mm and on 12 mm stroke 1000 mm.
- Shearing table with a number of square iron blocks, for easy sheet feed-in and increasing drastically operator's safety.
- Squaring arm of 1000 mm, with scale, T-slot and disappearing stop, attached to the left hand side of the machine.
- Movable foot pedal control.
- Instruction and maintenance manuals.
- Non-filled oil tank (because of environmental regulations)
- Service tools.



SC100 T CONTROL (OPTIONAL, = X MODEL)

TS EXECUTED WITH THE OPTIONAL SC100T CONTROL IS CALLED TSX.

PROGRAMMING MODES :

Basic features of the SC100 T control :

- LCD-display (5.7") with Touch Screen.
 - Memory capacity : max. 500 programs, max. 255 steps.
 - Material list of max. 32 materials.
 - Automatic blade gap and cutting angle setting.
 - Electro-hydraulic blade gap setting by means of 2 cylinders.
 - Stroke control adjustment (cutting length)
 - Automatic programmable retraction of the back gauge.
 - Possibility of jog mode on back gauge.
 - Backlash compensation, delayed sheet release.
 - Mode selection Inch-Metric.
 - (Preset) stroke counter up or down with 0-stop.
 - Language support.
 - USB interface
- **Automatic :**
By entering the sheet thickness, the control automatically sets the blade gap and the cutting angle as a function of the sheet thickness. All parameters can be manually modified according to the actual data.
 - **Manual :**
All cutting parameters such as material type, sheet thickness, cutting angle and blade gap can be programmed manually.





BACK GAUGES

The back gauge consists of 2 rigid arms (containing guides and control spindle) and the parallel adjustable back gauge bar. This assembly assures a precise positioning of the sheet. Swing-Away type enables cutting of sheets longer than the standard stroke length.

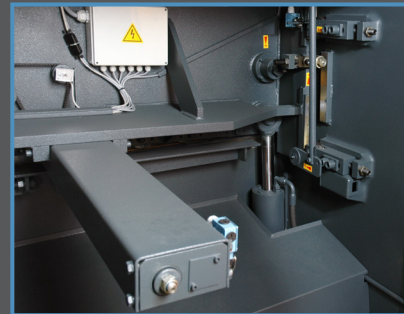

Motorised positioning with the SP9 preselection control or programmable positioning with the SC100 T control. Digital readout of the actual and pre-selected or programmed position. On the 6 mm models, motorised driven back gauge with a standard stroke of 750 mm and optional extension to 1000 mm. On the 12 mm model, motorised driven back gauge with standard stroke of 1000 mm.

Swing-Away back gauge

Powered back gauge, stroke 1000 mm. Available as option on all TS or TSX models. When removing the shafts in both carriers and run the backstop backwards, the complete carrier will swing away to the back, enabling to cut longer sheets.

QUICK AN EASY:

The **SC100 T** fits all requirements for sheet cutting operations that require the highest accuracy and minimum time-loss. Creating a program requires only a few actions. The program parameters include: back gauge position, cutting time, sheet thickness, blade angle & blade gap setting. The blade gap adjustment is done electro-hydraulically.

No specific training is required to work with this control!



Optional Equipment

- SC100T control unit (TSX type).
- Pendant control panel (only with SC100T controller).
- Squaring arms and front support arms.
- Ball transfers
- Protractor for angle shearing.
- Blades for cutting stainless steel.
- Hand safety guard with hand gaps and safety light curtain guards.
- Different back gauge types.
- Safety fences and light beams at the rear of the machine (necessary for countries requiring the CE safety specifications).



Hand safety guard with hand gaps for handling small sheets.

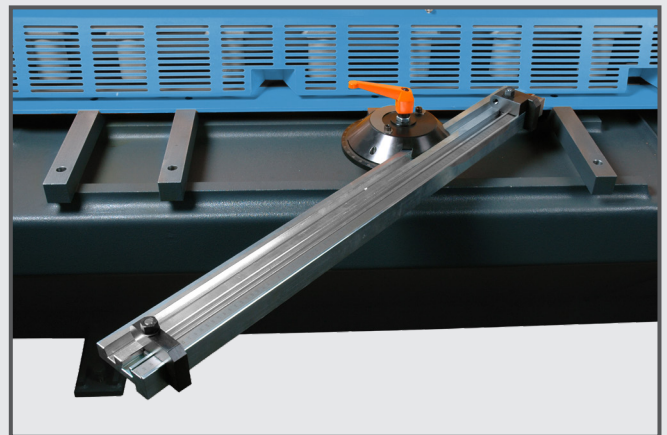

Protractor for Angle Shearing.

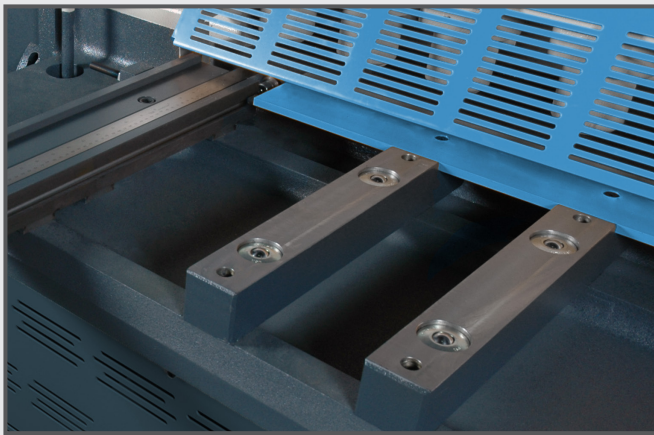

Ball transfers mounted in the iron table blocks, for easy feed-in of the sheets.

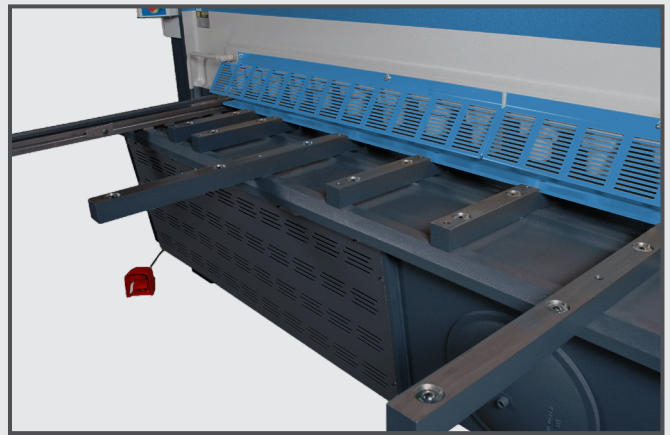

Squaring arms and front support arms with or without scale, T-slots and tilting stop. Lengths from 1000 up to 3000mm.

Technical Specifications TS / TSX - range

	Capacity mild steel (400N/mm ²) mm	Cutting length E mm	Cutting Angle Adjustment degrees	Number of plate hold downs	Number of strokes / min at max – min. angle.	Length squaring arm mm	Stroke back gauge MOT version mm	Stroke Back gauge SAB version (opt.) mm	Working height D mm	Motor Power kW	Length A mm	Width (without CE Safety fences) B mm	Width (including CE Safety fences) C mm	Height	Weight (approx.) kg
2006	6	2050	0.5-3	13	10-15	1000	750/1000	1000	770	7,5	2825	1900	2660	1660	3500
3006	6	3050	0.5-3	18	10-15	1000	750/1000	1000	770	7,5	3840	1900	2660	1700	4500
3012	12	3050	0.5-3	18	7-14	1000	750/1000	1000	930	22,5	4180	2030	2800	2210	8500

HACO reserves the right to change any specifications without prior notice.

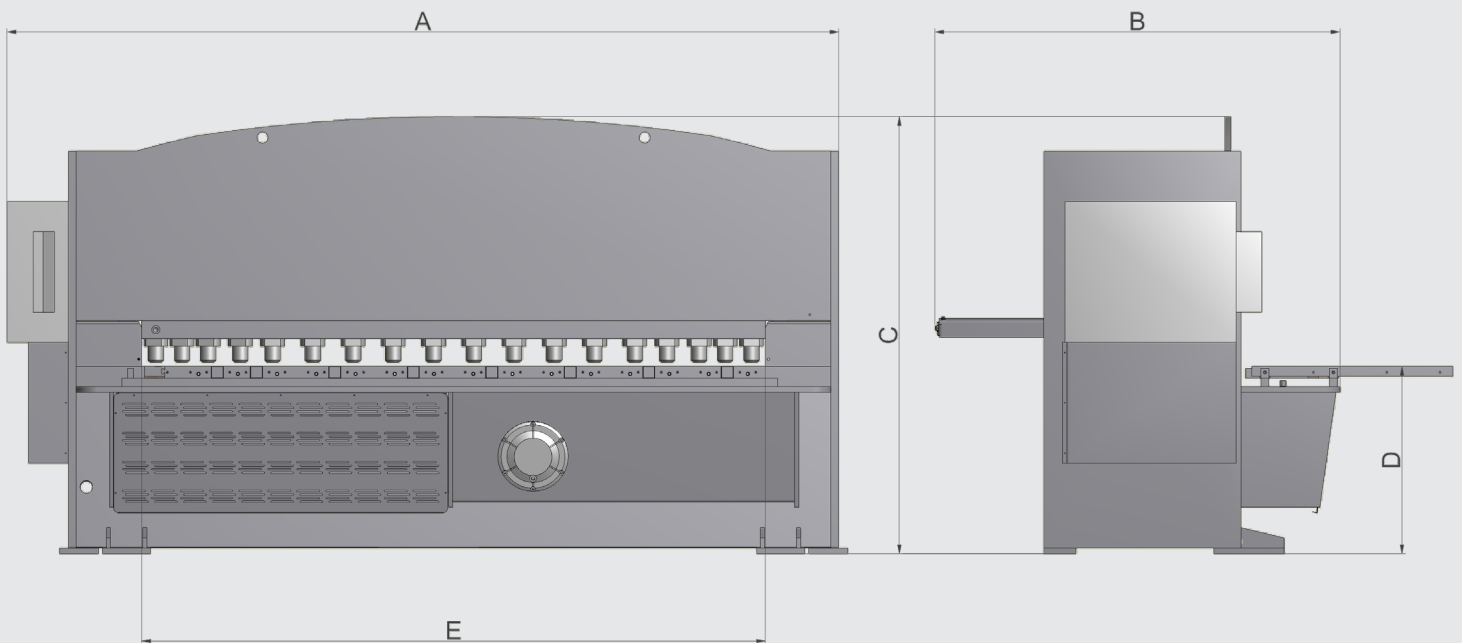



CNC Press Brakes



CNC Punching Machines



Plasma Cutting Machines

HACO NV
Oekensestraat 120
8800 Roeselare
Belgium
T +32 (0) 51 74 64 54
E-Mail: info@haco.com
www.haco.com

TS / TSX
Hydraulic Guillotine Shears

WWW.HACO.COM

For Impressive Performances