

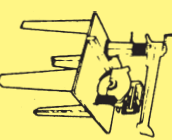
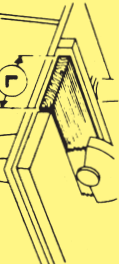
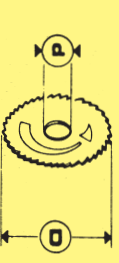

	H 90° m/m	H 45°	L m/m	m/m		m/m 45°		
				RA 60	100	50	600	715		600	
				RA 70	100	50	700	830		700	
				RA 90	100	50	850	980		870	
				R 1000	130	55	1000	1115		1000	
R 1250	130	55	1200	1350		1200					
				m/m	D m/m	d m/m	HP	G/1'			
				RA 60	950	350	35	3,5	3000		
				RA 70	1085	350	35	3,5	3000		
				RA 90	1200	350	35	3,5	3000		
				R 1000	1380	400	35	5,5	3000		
R 1250	1480	400	35	5,5	3000						
				m/m	m/m	Kg.					
				RA 60	1100x800	1100x1250	135				
				RA 70	1100x900	1100x1345	145				
				RA 90	1100x1000	1100x1480	200				
				R 1000	1200x1100	1200x1610	285				
R 1250	1500x1300	1500x1835	315								

#### LIVELLI DI RUMOROSITÀ NOISE LEVELS NIVEAUX DU BRUIT GERAUSCHPEGEL

				Livello di potenza sonora Sound power level Niveau de puissance sonore Schallleistungspiegel Nivel de potencia sonora	dB (A)	Livello medio di potenza sonora Average sound power level Niveau moyen de puissance sonore Durchschnittlicher Schallleistungspegel Nivel medio de potencia sonora	dB (A)	Livello medio di potenza sonora al posto operatore Sound power level at operator position Niveau du puissance sonore au poste de l'opérateur Schallleistungspegel am Arbeitsplatz Nivel de potencia sonora en el puesto del operador	dB (A)
				RA 60	96,2 dB (A)	90,7 dB (A)	89,5 dB (A)		
				RA 70	96,2 dB (A)	90,7 dB (A)	89,5 dB (A)		
				RA 90	96,9 dB (A)	90,7 dB (A)	89,9 dB (A)		
				R 1000	94,7 dB (A)	67,7 dB (A)	75,9 dB (A)		
R 1250	84,7 dB (A)	67,7 dB (A)	75,9 dB (A)						

**ATTENZIONE:** si informa che un'esposizione prolungata sopra gli 85 dB (A) può provocare danni alla salute. È pertanto consigliato l'uso di idonei sistemi di protezione (es. tappi, cuffie) come previsto dall'art. 46 del DL 277 del 15.8.91.

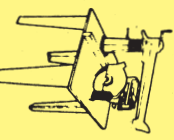
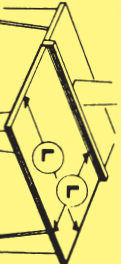
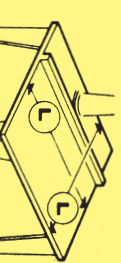
**CAUTION:** it must be noted prolonged exposure to noise levels above 85 dB (A) can be harmful to the health. We thus recommend that adequate protection be used (e.g. plugs, headphones) according to art. 46 Law 277 15.8.91.

**ATTENTION:** Nous informons qu'une exposition prolongée au dessus de 85 dB (A) peut nuire à la santé. Par conséquent, nous conseillons l'utilisation de systèmes de protection adéquats (ex.: bouchons, casques) aux termes de l'art. 46 de la Loi 277 15.8.91.

**VORSICHT:** Siverken Sie bitte, dass eine lange Exposition von über 85 dB (A) Ihre Gesundheit beschädigen kann. Es wird empfohlen zweckmassige Schutzsysteme (z.B.: Schutzkappen, Stopfen) zu benutzen, wie durch Art. 46 vom DL 277 15.8.91 vorgesehen.

**ATENCIÓN:** Se informa que una larga exposición sobre los 85 dB (A) puede provocar daños a la salud. Por lo tanto, se aconseja el uso de idoneos sistemas de protección (p.e.: casquillos, corchos) así como previsto en el art. 46 del DL 277 15.8.91.

La ditta contraffatta si riserva in qualsiasi momento di apportare modifiche a propria discrezione anche senza preavviso alle Spm, Clientela - Messes FRAMMAR have the right to modify their products without changing their main features - La Cie FRAMMAR se réserve la droit d'apporter à produits toutes les modifications qu'elle jugera utiles ou nécessaires, sans changer caractéristiques essentielles - Die FRAMMAR hat das Recht, jederzeit ihre Produkte nach Belieben zu modifizieren, auch ohne dies kundem zu benachrichtigen



OFFICINA MECCANICA  
**FRAMMAR**  
MACCHINE PER LA LAVORAZIONE DEL LEGNO S.R.L.

41012 CARPI (ITALY)  
Via Bramante, 32 - Tel: (059) 687299  
Fax (059) 650944  
e-mail: framarni@tin.it  
www.frammarcarpi.com

41012 CARPI (ITALY)  
Via Bramante, 32 - Tel: (059) 687299  
Fax (059) 650944  
e-mail: framarni@tin.it  
www.frammarcarpi.com

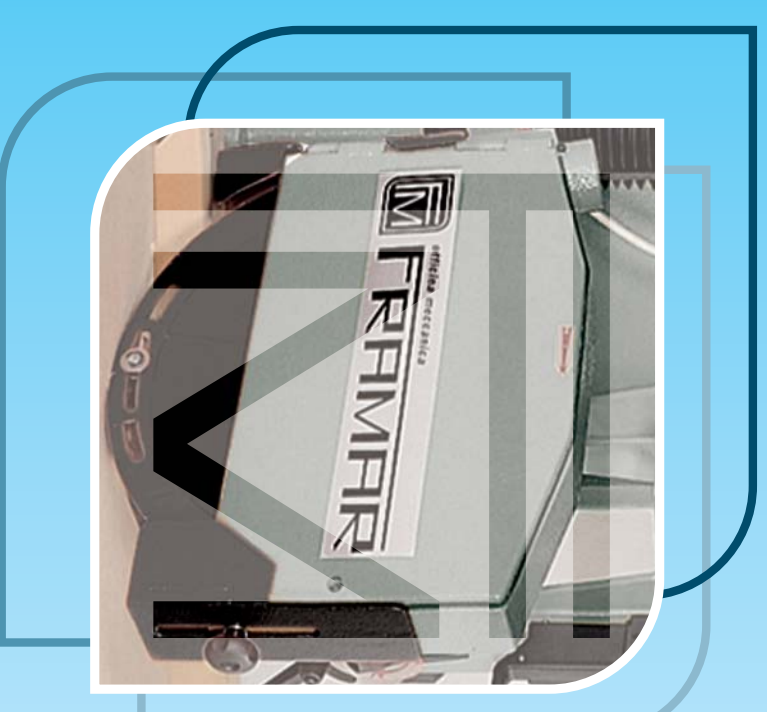

## LA RADIALE

Scies radiales

Radial saw

Auslegerkreissägemaschinen

Sierras radiales

**FRAMMAR**  
WOODWORKING MACHINERY

# RA 60 / 70 / 90

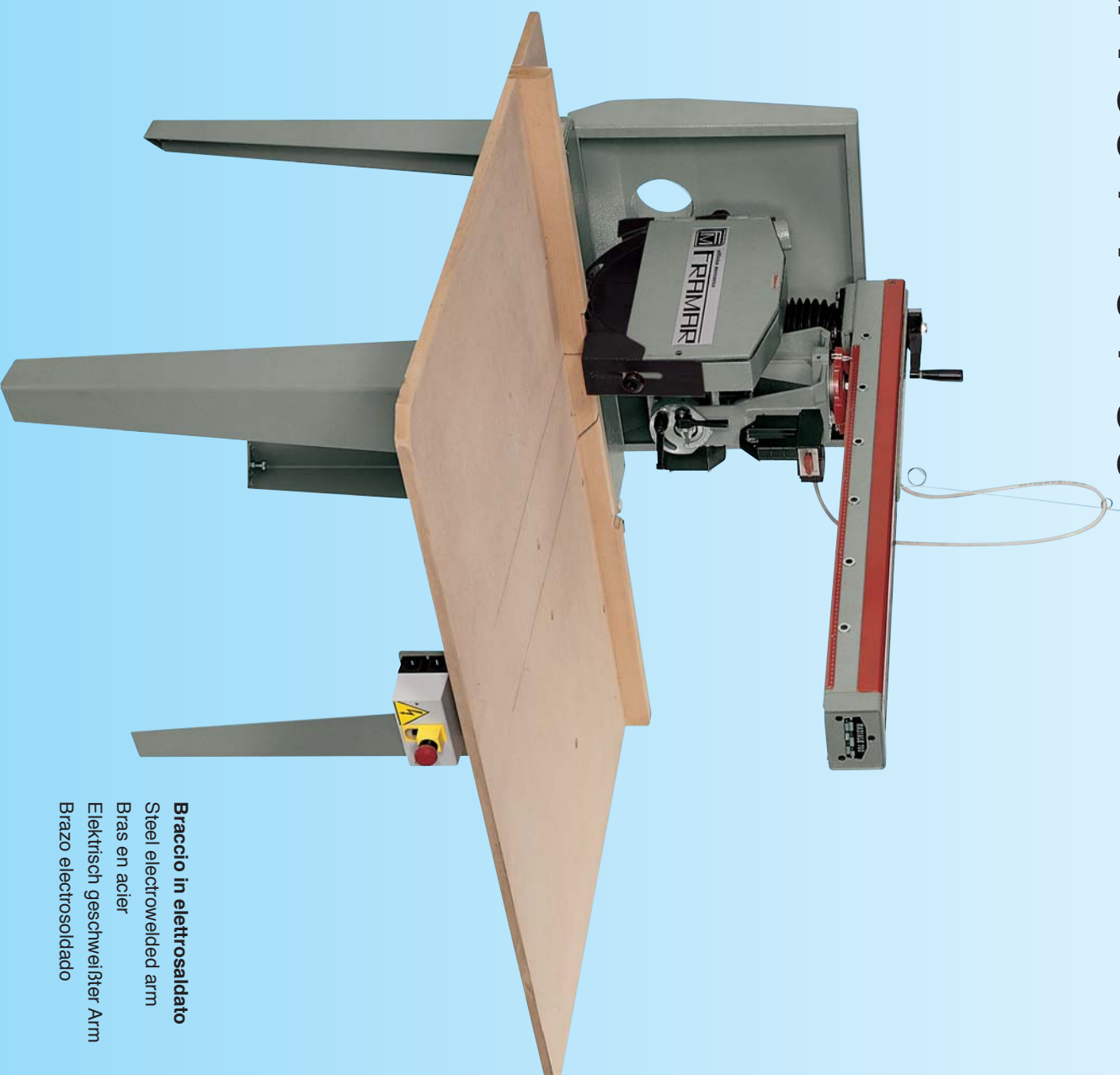

**Braccio in elettrosaldato**  
Steel electro-welded arm  
Bras en acier  
Elektrisch geschweißter Arm  
Brazo electrosoldado



**Galleggiante di protezione lama con lunette laterali automatiche.**  
Blade safety guard with automatic side rests.  
Carter de protección de la lame avec lunettes laterales automatiques.  
Blattschutzgerätause mit automatischen Seitenlunetten.  
Carter de protección de la hoja con lunetas laterales automaticas.

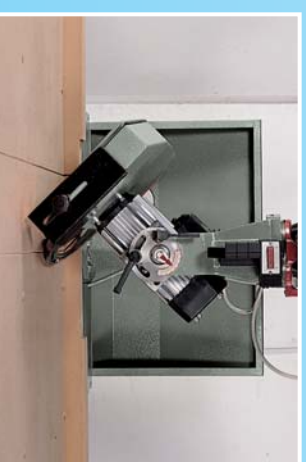

**Inclinazione gruppo lama con bloccaggio automatico a 0° and 45°.**  
Blade group tilting with automatic locking in 0° and 45° position.  
Inclinaison groupe lame avec blocages automatiques à 0° et 45°.  
Neigung des Blattaggregates mit automatischer Spernung um 0° und 45°.  
Inclinación conjunto hoja con bloqueo automático a 0° y 45°.

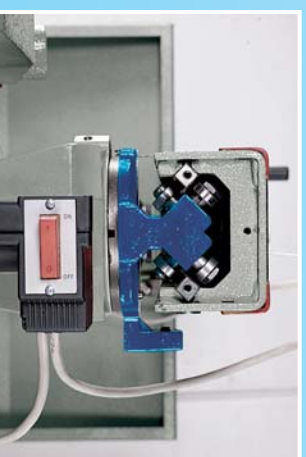

**Scorrimento gruppo lama tramite 8 cuscinetti regolabili su guide intercambiabili.**  
Blade group sliding on 8 adjustable bearings fitted on interchangeable guide.  
Ecouler groupe lame avec 8 réglables roulement fixe sur guides interchangeables.  
Gleiten des Blattaggregates durch 8 verstellbare Kugellager auf austauschbaren Führungen.  
Deslizamiento conjunto hoja por medio de 8 rodamientos ajustables en guías intercambiables.

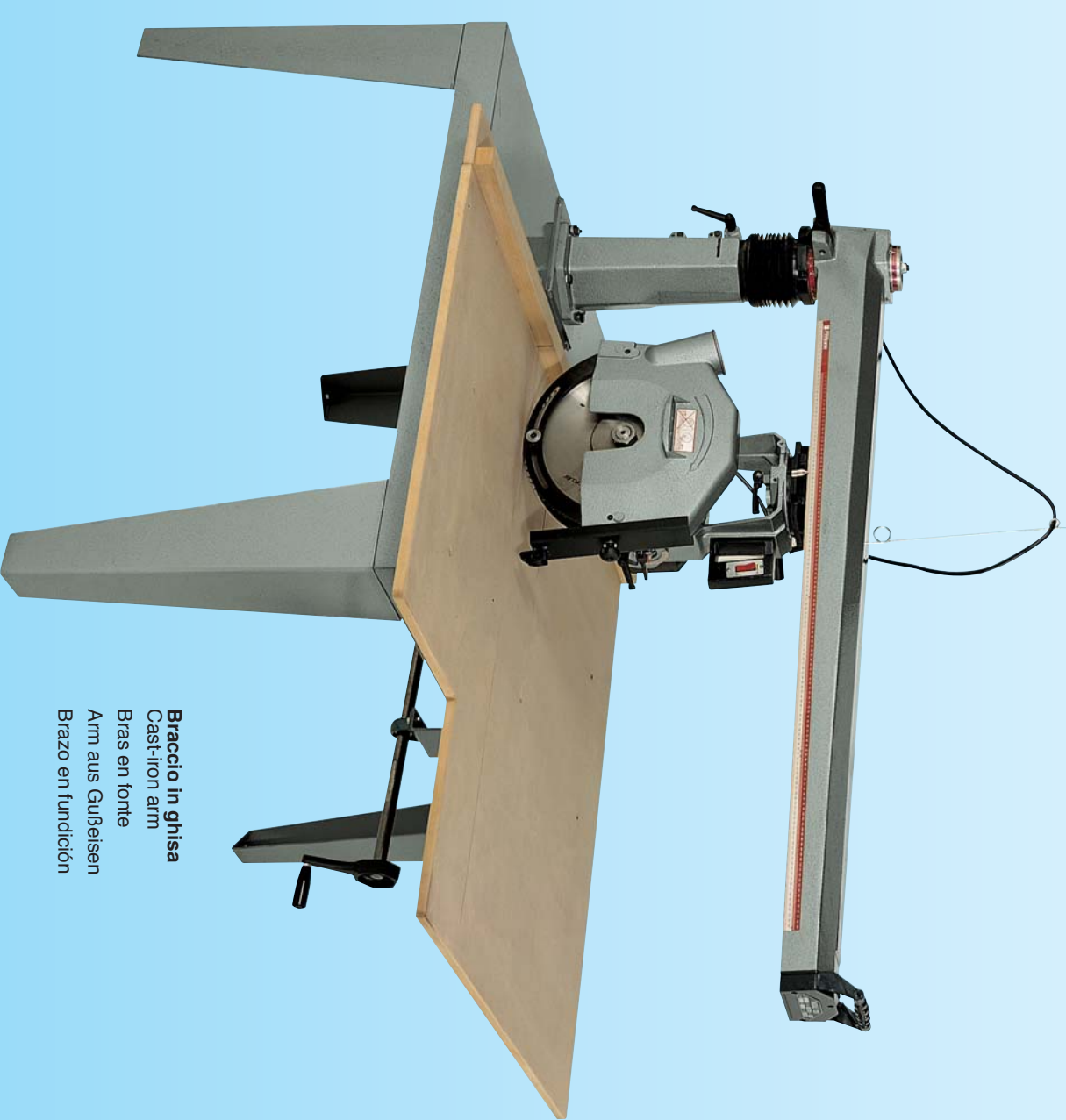

**Braccio in ghisa**  
Cast-iron arm  
Bras en fonte  
Arm aus Gußeisen  
Brazo en fundición



**Rotazione braccio con bloccaggio automatico 0° e 45°.**  
- **Particolare della predisposizione all'aspirazione.**  
- Arm rotation with automatic locking in 0° and 45° position.  
- View of the dust-collecting arrangement.  
- Rotation du bras avec blocages automatiques à 0° et 45°.  
- Detaille de la predisposition pour l'aspiration.  
- Armschwenkung mit automatischer Spernung um 0° und 45°.  
- Detail der Absaugvorbereitung.  
- Rotación brazo con bloqueo automático a 0° y 45°.  
- Detalle de la predisposición a la aspiración.

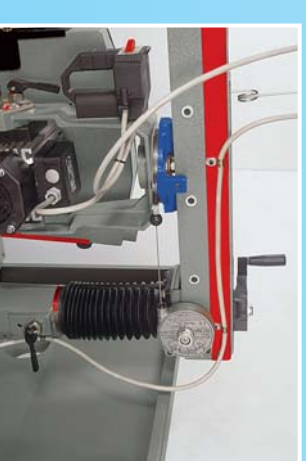

**Dispositivo automatico per il ritorno della testa.**  
Automatic device for head return.  
Dispositif automatique de retour de la tête.  
Automatische Vorrichtung für Kopfdruckkehr.  
Dispositivo automatico de retorno de la cabeza.